



# LIQUID TIGHT POLYSTYRENE ENCLOSURES

for Indoor Installations



| ORDER NUMBER<br>(GREY) | BOX SIZE | DIMENSIONS       |                 |                                |                                      |                                |   | SIDE PANEL CONFIGURATION<br>No. of Holes and Size | GROMMETS INCLUDED<br>(IP 55, NEMA 12) | MOUNT WITH #8-UNC SCREWS |
|------------------------|----------|------------------|-----------------|--------------------------------|--------------------------------------|--------------------------------|---|---|---------------------------------------|--------------------------|
|                        |          | INCHES           |                 |                                | MM                                   |                                |   |   |                                       |                          |
|                        |          | W                | H               | D                              | W                                    | H                              | D |   |                                       |                          |
| D 9020<br>D 9120       | 1        | 3.5 x 3.5 x 2.1  | 88 x 88 x 53    | 7 M20<br>7 M20                 | 4 x ESM 20 (M20)<br>4 x ESM 20 (M20) | 2 Inside Box<br>2 Outside Lugs |   |   |                                       |                          |
| D 8020<br>D 8120       | 1        | 3.5 x 3.5 x 2.1  | 88 x 88 x 53    | Smooth<br>Smooth               | -<br>-                               | 2 Inside Box<br>2 Outside Lugs |   |   |                                       |                          |
| D 9040<br>D 8040       | 2        | 3.9 x 3.9 x 2.3  | 98 x 98 x 58    | 7 M25<br>Smooth                | 4 x ESM 25 (M25)<br>-                | 2 Inside Box<br>2 Inside Box   |   |   |                                       |                          |
| K 9060<br>K 8060       | 3        | 5.5 x 4.7 x 2.8  | 139 x 119 x 70  | 4 M25 + 6 M25/32<br>Smooth     | 3 x ESM 32 (M32)<br>-                | 4 Inside Box<br>4 Inside Box   |   |   |                                       |                          |
| K 9100<br>K 8100       | 4        | 6.6 x 4.9 x 3.2  | 167 x 125 x 82  | 10 M25/32<br>Smooth            | 3 x ESM 32 (M32)<br>-                | 4 Inside Box<br>4 Inside Box   |   |   |                                       |                          |
| K 9250<br>K 8250       | 5        | 7.9 x 6.3 x 3.9  | 200 x 160 x 98  | 10 M32/40<br>Smooth            | 3 x ESM 40 (M40)<br>-                | 4 Inside Box<br>4 Inside Box   |   |   |                                       |                          |
| K 9500<br>K 8500       | 6        | 12.2 x 8.3 x 4.6 | 310 x 210 x 116 | 10 M25/32 + 4 M40/50<br>Smooth | -<br>-                               | 4 Inside Box<br>4 Inside Box   |   |   |                                       |                          |

Reference our Web Site at [www.hitechcontrols.com](http://www.hitechcontrols.com) for our full product line & technical information!

For Strain Relief Fittings see Page 8 or Web Site!

**Dimensions**

**DIN Rail**

**with Mounting Brackets**

PAGE 3

**NPT Hubs**

**Impact Resistant**

**UV Resistant**

# LIQUID TIGHT POLYCARBONATE ENCLOSURES

HALOGEN FREE for Outdoor and Harsh Environments (Impact & UV Resistant)



| ORDER NUMBER<br>(GREY) | ORDER NUMBER<br>(BLACK) | BOX SIZE | DIMENSIONS       |                 |                                |                              |   |   | SIDE PANEL CONFIGURATION<br>No. of Holes and Size | MOUNT WITH #8-UNC SCREWS |
|------------------------|-------------------------|----------|------------------|-----------------|--------------------------------|------------------------------|---|---|---|--------------------------|
|                        |                         |          | INCHES           |                 |                                | MM                           |   |   |   |                          |
|                        |                         |          | W                | H               | D                              | W                            | H | D |   |                          |
| KF 9020<br>KF 8020     | KF 5020<br>-            | 1        | 3.5 x 3.5 x 2.1  | 88 x 88 x 53    | 7 M20<br>Smooth                | 2 Inside Box<br>2 Inside Box |   |   |   |                          |
| KF 9040<br>KF 8040     | KF 5040<br>-            | 2        | 3.9 x 3.9 x 2.3  | 98 x 98 x 58    | 7 M25<br>Smooth                | 2 Inside Box<br>2 Inside Box |   |   |   |                          |
| KF 9060<br>KF 8060     | KF 5060<br>-            | 3        | 5.5 x 4.7 x 2.8  | 139 x 119 x 70  | 4 M25 + 6 M25/32<br>Smooth     | 4 Inside Box<br>4 Inside Box |   |   |   |                          |
| KF 9100<br>KF 8100     | KF 5100<br>-            | 4        | 6.6 x 4.9 x 3.2  | 167 x 125 x 82  | 10 M25/32<br>Smooth            | 4 Inside Box<br>4 Inside Box |   |   |   |                          |
| KF 9250<br>KF 8250     | KF 5250<br>-            | 5        | 7.9 x 6.3 x 3.9  | 200 x 160 x 98  | 10 M32/40<br>Smooth            | 4 Inside Box<br>4 Inside Box |   |   |   |                          |
| KF 9500<br>KF 8500     | KF 5500<br>-            | 6        | 12.2 x 8.3 x 4.6 | 310 x 210 x 116 | 10 M25/32 + 4 M40/50<br>Smooth | 4 Inside Box<br>4 Inside Box |   |   |   |                          |

Reference our Web Site at [www.hitechcontrols.com](http://www.hitechcontrols.com) for our full product line & technical information!

For Strain Relief Fittings see Page 8 or Web Site!

## SPECIFICATIONS

- Liquid Tight:** NEMA 4x (IP65)
- Temperature:** -40°F to 212°F (-40°C to 100°C)
- Cover Screws:** 304 Stainless Steel
- Cover Seal:** TPE (Thermoplastic Elastomer)
- Max. Voltage:** 670 V

|                  | D/K SERIES           | KF SERIES                                 |
|------------------|----------------------|---|
| <b>MATERIAL:</b> | Polystyrene          | Polycarbonate<br>(glass fiber reinforced) |
| <b>COLOR:</b>    | Grey RAL 7035<br>N/A | Grey RAL 7032<br>Black RAL 9011           |

**Enclosure Sides:** With Metric knock-outs or smooth for custom drilling. The knock-outs for Metric threads have the following diameters: M20 = .79", M25 = .98", M32 = 1.26", M40 = 1.57", M50 = 1.97".



# LISTED LIQUID TIGHT POLYCARBONATE ENCLOSURES

## HALOGEN FREE for Outdoor and Harsh Environments (Impact & UV Resistant)



C<sub>UL</sub> (meets  $\text{SP}$  requirements, tested by  $\text{UL}$ ) listed enclosures with smooth sides and external mounting provisions can be used with DIN rail or mounting plate. The mounting brackets and hardware are also available as a kit. Order Number DK AL 2 to convert a standard series KF 8000 enclosure into a C<sub>UL</sub> listed enclosure (1 – 5 only).

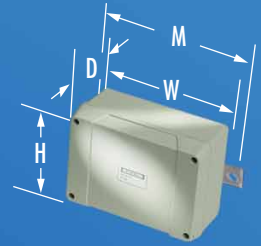

Reference our Web Site at [www.hitechcontrols.com](http://www.hitechcontrols.com) for our full product line & technical information!

For Strain Relief Fittings see Page 8 or Web Site!

| ORDER NUMBER | BOX SIZE | DIMENSIONS |     |       |      |     |       |      |     | SIDE PANEL CONFIGURATION | MOUNT WITH #8-UNC SCREWS |
|--------------|----------|------------|-----|-------|------|-----|-------|------|-----|--------------------------|--------------------------|
|              |          | INCHES     |     |       |      | MM  |       |      |     |                          |                          |
|              |          | W          | H   | D     | M    | W   | H     | D    | M   |                          |                          |
| KF 7020      | 1        | 3.5        | 3.5 | x 2.1 | 4.46 | 88  | x 88  | x 53 | 113 | Smooth                   | 2 Brackets               |
| KF 7040      | 2        | 3.9        | 3.9 | x 2.3 | 4.74 | 98  | x 98  | x 58 | 121 | Smooth                   | 2 Brackets               |
| KF 7060      | 3        | 5.5        | 4.7 | x 2.8 | 6.47 | 139 | x 119 | x 70 | 164 | Smooth                   | 2 Brackets               |
| KF 7100      | 4        | 6.6        | 4.9 | x 3.2 | 7.57 | 167 | x 125 | x 82 | 192 | Smooth                   | 2 Brackets               |
| KF 7250      | 5        | 7.9        | 6.3 | x 3.9 | 8.87 | 200 | x 160 | x 98 | 225 | Smooth                   | 4 Brackets               |

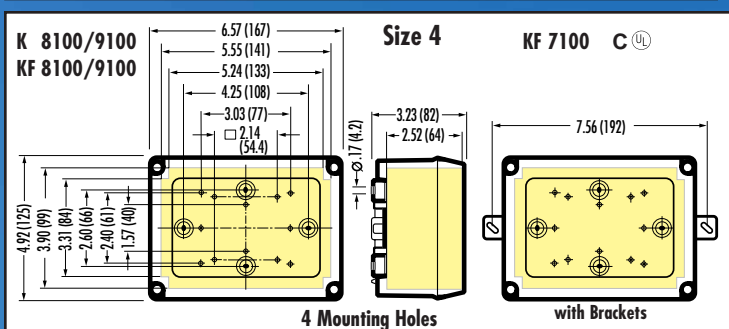
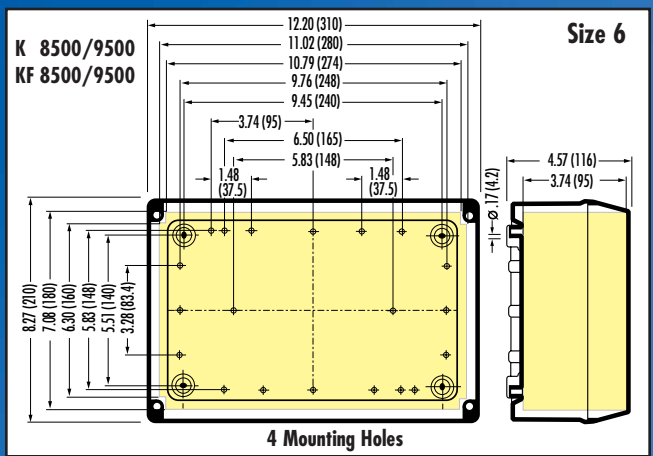
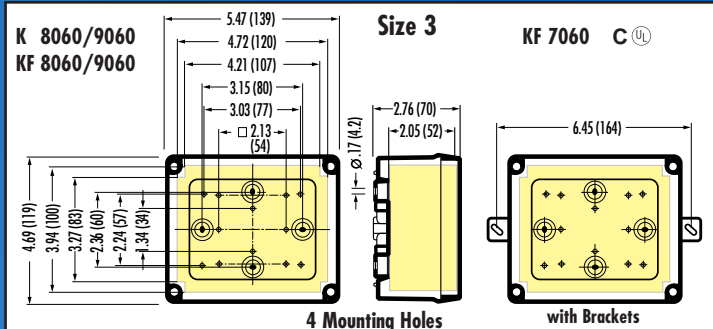
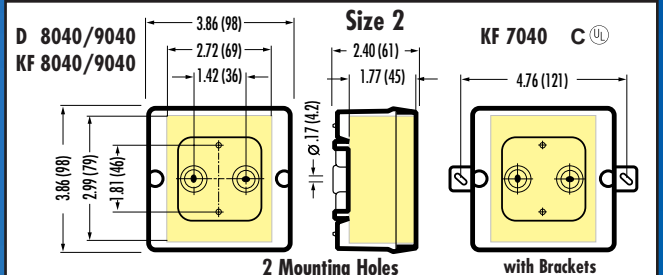
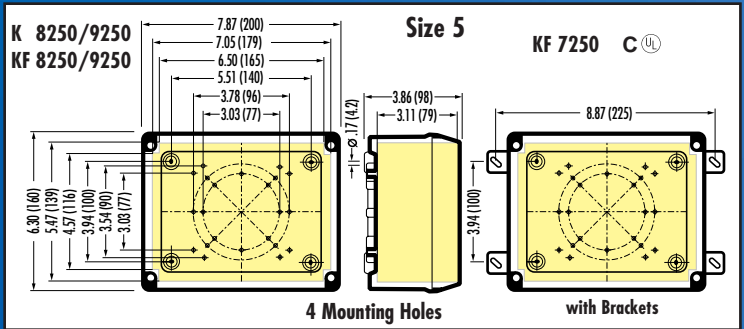
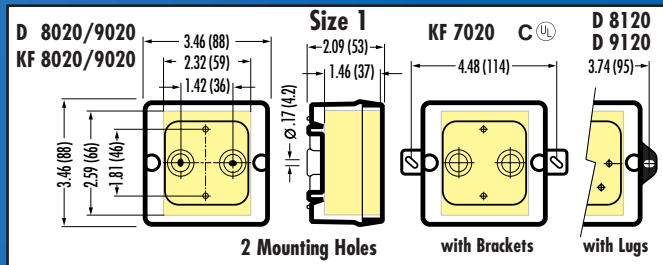

### Notes:

1. Knock-outs are liquid tight until punched out with screwdriver. (See page 6).
2. Smooth sides can be drilled, punched or milled. NPT hubs are available.
3. Yellow shaded area is useable space in enclosure.
4. Mounting screws are #8 UNC (.16"  $\phi$ ). If used indoors, punch or drill holes and cap recess with rubber plugs located inside cover.

For D, K and KF Series

# MOUNTING PLATES

(for box sizes 3 to 6)

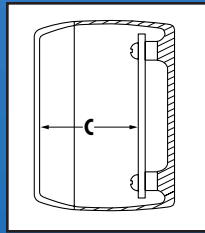
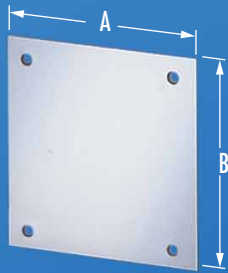

Allows easy installation of components outside of enclosure. Kit includes  $\frac{1}{8}$ " plate,  $\frac{3}{16}$ " stand-offs and mounting screws.

| BOX SIZE | ORDER NUMBER | SIZE A x B in (mm)     | CLEARANCE C in (mm) |
|----------|--------------|------------------------|---------------------|
| 3        | K MP 06      | 4.0 x 3.0 (101 x 76)   | 1.65 (42)           |
| 4        | K MP 10      | 5.0 x 3.5 (127 x 89)   | 2.13 (54)           |
| 5        | K MP 25      | 6.3 x 4.8 (160 x 122)  | 2.72 (69)           |
| 6        | K MP 55      | 10.0 x 6.5 (254 x 165) | 3.35 (85)           |

For D, K and KF Series

# DIN RAILS

CE-HAR-VDE

EN 50 022 (35 mm)

EN 50 045 (15 mm)

Meets all European and US standards. Used with snap-on terminal blocks, relays etc. Kit includes rail and screws.

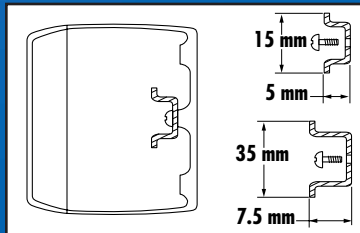
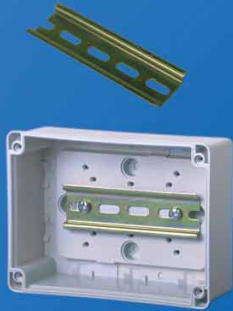

| BOX SIZE | ORDER NUMBER | RAIL SIZE (mm) | RAIL LENGTH in (mm) |
|----------|--------------|----------------|---------------------|
| 1        | TSD 02       | 15             | 2.24 (57)           |
| 2        | TSD 04       | 15             | 3.23 (82)           |
| 3        | TSK 06       | 35             | 4.13 (105)          |
| 4        | TSK 10       | 35             | 6.02 (153)          |
| 5        | TSK 25       | 35             | 7.01 (178)          |
| 6        | TSK 50       | 35             | 11.42 (290)         |

For D, K and KF Series

# TERMINAL BLOCKS

CE-HAR-VDE

Meets all European and US standards. Plug or screw terminal blocks into holes inside enclosure. Provides clean power distribution. Maximum Voltage = 600V.

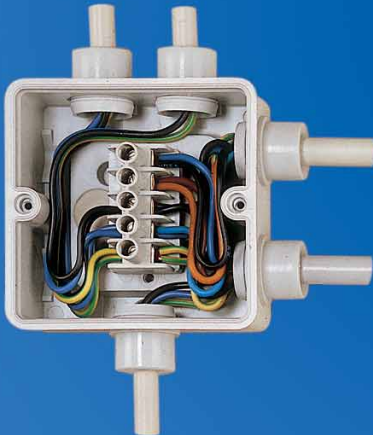

| BOX SIZE | ORDER NUMBER | NO. OF POLES | NUMBER AND SIZE WIRE PER POLE (mm <sup>2</sup> ) | MAX. POWER (Amp.) |
|----------|--------------|--------------|--|-------------------|
| 1 & 2    | DKL 04       | 5            | 3 x 4.0, 4 x 2.5, 6 x 1.5                        | 35                |
| 3        | KKL 06       | 5            | 3 x 6.0, 4 x 4.0, 4 x 2.5                        | 40                |
| 4        | KLS 10       | 5            | 4 x 10.0, 4 x 6.0, 4 x 4.0                       | 63                |
| 5 & 6    | KLS 25       | 5            | 4 x 25.0, 4 x 16.0, 4 x 10.0                     | 102               |
| 6        | KLS 54       | 4            | 4 x 70.0, 4 x 50.0, 4 x 35.0, 4 x 25.0, 4 x 16.0 | 216               |
| 6        | KLS 55       | 5            | 4 x 50.0, 4 x 35.0, 4 x 25.0, 4 x 16.0           | 170               |



DKL 04



KKL 06



KLS 10



KLS 25



KLS 54



KLS 55

# HUB KITS — METRIC TO NPT

Hub Kits include NPT adapter and nut. Fits knock-out in box. Converts hole which fits Metric thread to a female NPT threaded hub.

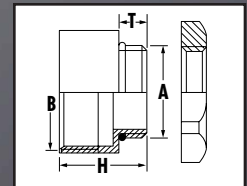

**Materials:**

Body & Nut: Nickel Plated Brass

O-Ring: Buna-N

| ORDER NUMBER | MALE THREAD A | FEMALE THREAD B | WRENCHING FLATS W | THREAD LENGTH T | HEIGHT H |
|--------------|---------------|-----------------|-------------------|-----------------|----------|
| AM-2012-BR-N | M20 x 1.5     | 1/2" NPT        | .94               | .24             | .91      |
| AM-2512-BR-N | M25 x 1.5     | 1/2" NPT        | 1.18              | .28             | .59      |
| AM-2534-BR-N | M25 x 1.5     | 3/4" NPT        | 1.18              | .28             | 1.02     |
| AM-3210-BR-N | M32 x 1.5     | 1" NPT          | 1.57              | .32             | 1.22     |
| AM-3254-BR-N | M32 x 1.5     | 1-1/4" NPT      | 1.77              | .32             | 1.34     |

# Mi LIQUID TIGHT MODULAR POLYCARBONATE ENCLOSURES



Hinges available for all sizes!

See page 8 or Web site for our Strain Relief solution!

Various sizes can be combined to make larger enclosures. The intermediate walls can be knocked out. Made of impact resistant polycarbonate, these enclosures meet NEMA 4x (IP 65) but have only a limited UV resistance. If used outdoors, protection against direct sunlight should be provided. All enclosures are available with transparent or opaque covers. Cover screws can be replaced with a special hinged screw to convert any size into an enclosure with hinged cover. More information about the system and the many accessories, such as connection kits, grommets and strain relief fittings are available in the MASTER CATALOG or check our web site: [www.hitechcontrols.com](http://www.hitechcontrols.com)

## SPECIFICATIONS

**Temperature Range:** -40°F to 158°F (-40°C to 70°C)  
**Material:** Polycarbonate  
 Limited UV resistance  
 Halogen and silicone free

**Protection:** NEMA 4x (IP65)

### Notes:

1. Dimensions are in inches (mm).
2. Yellow shaded area is useable space in enclosure.
3. Knock-outs are liquid tight until punched out.
4. Enclosure mounting holes for M6 or 12-24 UNC screws are located below the cover mounting screws.

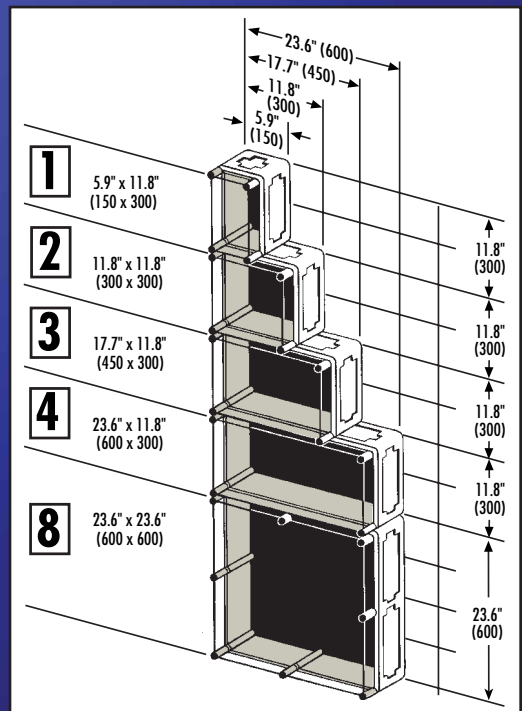
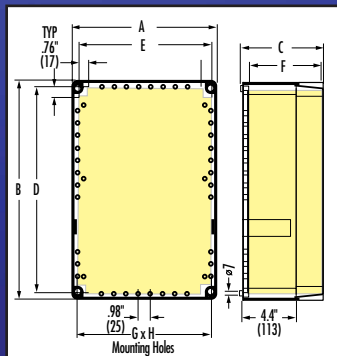
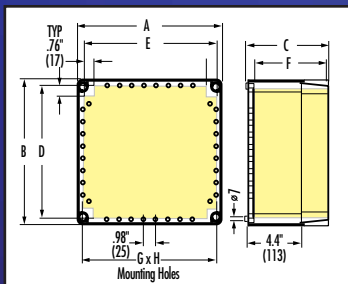

| BASIC SIZE | ORDER NUMBER  |              | DIMENSIONS INCHES (MM) |            |           |                |            |           |                |            |
|------------|---------------|--------------|------------------------|------------|-----------|----------------|------------|-----------|----------------|------------|
|            | COVER TRANSP. | COVER OPAQUE | ENCLOSURE SIZE         |            |           | INTERNAL SPACE |            |           | MOUNTING HOLES |            |
|            |               |              | A - LENGTH             | B - WIDTH  | C - DEPTH | D - LENGTH     | E - WIDTH  | F - DEPTH | G              | H          |
| 1          | Mi 0100       | Mi 0101      | 11.8 (300)             | 5.9 (150)  | 6.7 (170) | 4.8 (122)      | 10.7 (272) | 5.7 (146) | 10.8 (275)     | 4.9 (125)  |
| 2          | Mi 0200       | Mi 0201      | 11.8 (300)             | 11.8 (300) | 6.7 (170) | 10.7 (272)     | 10.7 (272) | 5.7 (146) | 10.8 (275)     | 4.9 (125)  |
| 2          | Mi 0210       | Mi 0211      | 11.8 (300)             | 11.8 (300) | 8.4 (214) | 10.7 (272)     | 10.7 (272) | 7.5 (191) | 10.8 (275)     | 10.8 (275) |
| 2*         | Mi 0220       | Mi 0221      | 11.8 (300)             | 11.8 (300) | 7.2 (182) | 10.7 (272)     | 10.7 (272) | 4.5 (115) | 10.8 (275)     | 10.8 (275) |
| 3          | Mi 0300       | Mi 0301      | 11.8 (300)             | 17.7 (450) | 6.7 (170) | 16.6 (422)     | 10.7 (272) | 5.7 (146) | 10.8 (275)     | 16.7 (425) |
| 3          | Mi 0310       | Mi 0311      | 11.8 (300)             | 17.7 (450) | 8.4 (214) | 16.6 (422)     | 10.7 (272) | 7.5 (191) | 10.8 (275)     | 16.7 (425) |
| 4          | Mi 0400       | Mi 0401      | 11.8 (300)             | 23.6 (600) | 6.7 (170) | 22.5 (572)     | 10.7 (272) | 6.7 (170) | 10.8 (275)     | 20.6 (525) |
| 4          | Mi 0410       | Mi 0411      | 11.8 (300)             | 23.6 (600) | 8.4 (214) | 22.5 (572)     | 10.7 (272) | 8.4 (214) | 10.8 (275)     | 20.6 (525) |
| 8          | Mi 0800       | Mi 0801      | 23.6 (600)             | 23.6 (600) | 6.7 (170) | 22.5 (572)     | 22.5 (572) | 5.7 (146) | 20.6 (525)     | 20.6 (525) |

\*Note: Mi 0220 and Mi 0221 feature a hinged cover.

For Mi Series

## MOUNTING PLATES

Made of 5/32" (4 mm) insulating material. 4 screws included. Components can be installed with self-tapping screws.



| ORDER NUMBER | BASIC SIZE | DIMENSIONS in (mm)      |
|--------------|------------|-------------------------|
| Mi MP 1      | 1, 3, 4    | 10.2 x 4.5 (259 x 115)  |
| Mi MP 2      | 2 to 8     | 10.4 x 10.4 (265 x 265) |
| Mi MP 3      | 3, 4       | 10.4 x 16.3 (265 x 415) |
| Mi MP 4      | 4, 8       | 10.4 x 22.2 (265 x 565) |
| Mi MP 8      | 8          | 22.2 x 22.2 (565 x 565) |



For Mi Series

## EXTENSION FRAME

Increases the depth of enclosures 4 and 8 by 3.3" (85 mm). Mounting hardware included.



| ORDER NUMBER | BASIC SIZE | DIMENSIONS in (mm)      |
|--------------|------------|-------------------------|
| Mi ZR 4      | 4          | 11.8 x 23.6 (300 x 600) |
| Mi ZR 8      | 8          | 23.6 x 23.6 (600 x 600) |



For Mi Series

## DIN RAILS EN 50 022 (35 mm)



| ORDER NUMBER | BASIC SIZE | DIMENSIONS in (mm) |
|--------------|------------|--------------------|
| Mi TS 30     | 1 to 8     | 11.2 (284)         |
| Mi TS 45     | 3          | 17.1 (434)         |
| Mi TS 60     | 4, 8       | 23.0 (584)         |

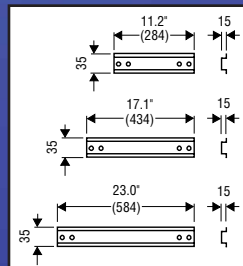

For components with clip-on or clamp attachment. Mounting screws are included.

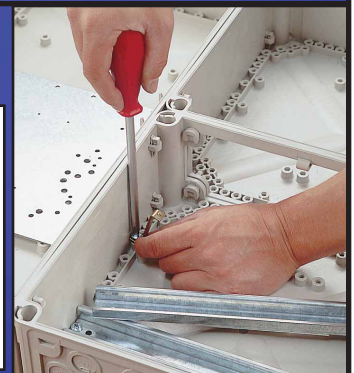

## KNOCK-OUTS

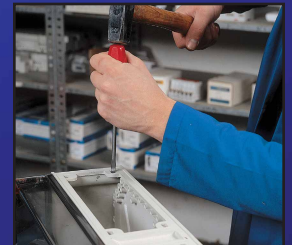
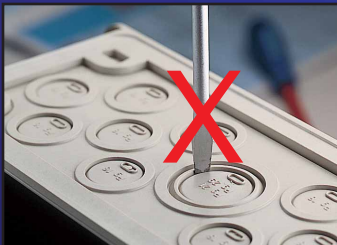

# KG/KV LIQUID TIGHT ENCLOSURES

The KG & KV Series have transparent covers with special saddle shaped sides allows easy observation and quick access to the installed components. Only, KG Series is hinged! The housing is made of polystyrene, the cover is made of impact resistant polycarbonate. These enclosures meet NEMA 4x (IP 65). Four different sizes are available along with DIN rails and mounting plates.

## KG 9001



Hinged

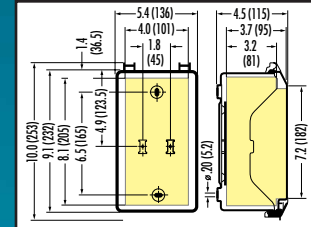
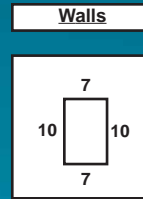
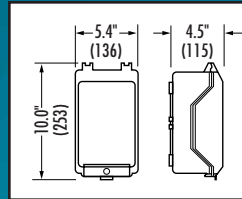

## KG 9002



Hinged

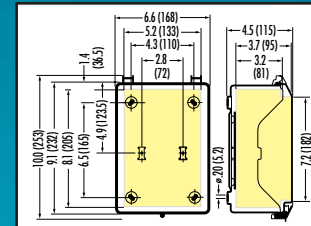
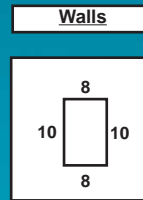
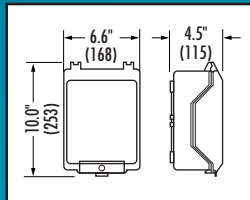

## KG 9003



Hinged

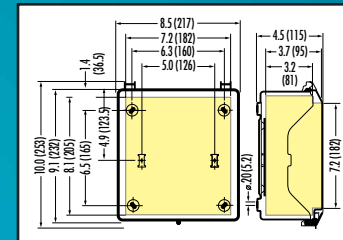
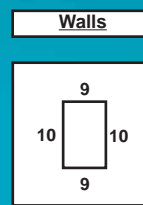
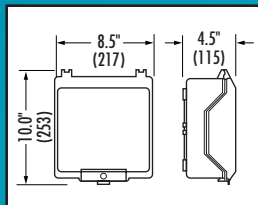

## KV 9331

Included:  
Mounting Plate



Not Hinged

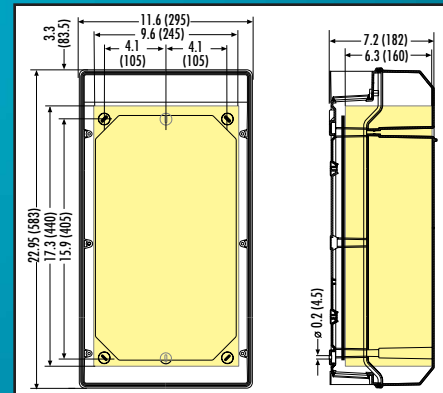
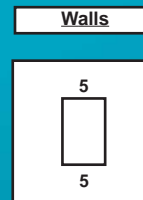
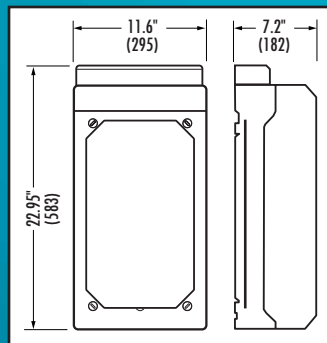

## SPECIFICATIONS

**Temperature Range:** -40°F to 158°F (-40°C to 70°C)  
**Material: Housing:** Polystyrene  
**Cover:** Polycarbonate  
**Protection:** NEMA 4x (IP65)

### Notes:

1. Dimensions are in inches (mm).
2. Yellow shaded area is useable space in enclosure.
3. Knock-outs are liquid tight until punched out with screwdriver. (See page 6.)
4. Mounting holes for M4 or #8 screws are inside the enclosure. Punch or drill holes and cap recess with rubber plugs (Encl.).

### INTEGRATED ELASTIC MEMBRANES FOR CABLE FEED-THROUGH.

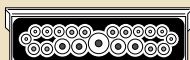

**Wall 5:**  
 8 x  $\emptyset$  7 - 12 mm  
 8 x  $\emptyset$  7 - 14 mm  
 1 x  $\emptyset$  11 - 20 mm  
 1 x  $\emptyset$  10 - 20 mm



**Wall 7:**  
 2 x M20  
 2 x M25  
 1 x M32/40



**Wall 8:**  
 4 x M20  
 2 x M25/32  
 1 x M32/40



**Wall 9:**  
 6 x M20  
 2 x M25/32  
 1 x M32/40



**Wall 10:**  
 2 x PG16

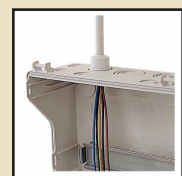

**Grommets**  
ESM - IP 55

For KG Series

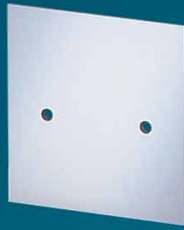

# MOUNTING PLATES

Made of 5/32" (4 mm) plastic material. 4 Screws included.  
Components can be installed with self-tapping screws.

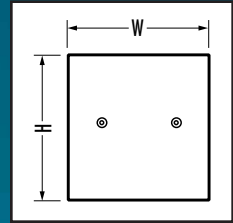

| ORDER NO.       | ENCLOSURE   | W X H inches (mm)       |
|-----------------|-------------|-------------------------|
| <b>KG MP 01</b> | for KG 9001 | 3.9" x 5.4" (100 x 136) |
| <b>KG MP 02</b> | for KG 9002 | 5.1" x 5.4" (130 x 136) |
| <b>KG MP 03</b> | for KG 9003 | 7.1" x 5.4" (180 x 136) |

For KG Series



# DIN RAILS EN 50 022 (35 mm)

For components with clip-on or clamp attachment.  
Mounting screws are included.

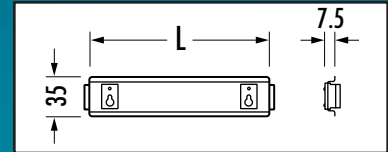

| ORDER NO.       | ENCLOSURE   | LENGTH L inches (mm) |
|-----------------|-------------|----------------------|
| <b>KG TS 01</b> | for KG 9001 | 3.2" (81)            |
| <b>KG TS 02</b> | for KG 9002 | 4.3" (108)           |
| <b>KG TS 03</b> | for KG 9003 | 6.4" (162)           |

# LIQUID TIGHT NYLON STRAIN RELIEF FITTINGS

Meet NEMA 4x (IP 65) & NEMA 6 (IP 68)

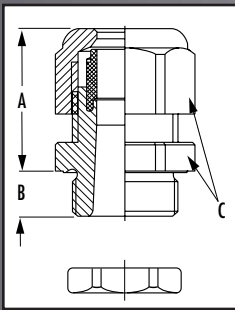

\*Note: Locking nut is included.

| ORDER NUMBER* |             | THREAD | CABLE RANGE<br>INCHES (MM) | DIMENSIONS INCHES (MM) |            |             |
|---------------|-------------|--------|----------------------------|------------------------|------------|-------------|
| BLACK         | GRAY        |        |                            | A                      | B          | C           |
| CD20MA-BK-N   | CD20MA-GY-N | M20    | .24 - .47 (6.0 - 12.0)     | 1.06 (27.0)            | .35 (9.0)  | .94 (24.0)  |
| CD20MR-BK-N   | CD20MR-GY-N |        | .20 - .35 (5.0 - 9.0)      |                        |            |             |
| CD22MA-BK-N   | CD22MA-GY-N | M20    | .39 - .55 (10.0 - 14.0)    | 1.10 (28.0)            | .35 (9.0)  | 1.06 (27.0) |
| CD22MR-BK-N   | CD22MR-GY-N |        | .28 - .47 (7.0 - 12.0)     |                        |            |             |
| CD25MA-BK-N   | CD25MA-GY-N | M25    | .51 - .71 (13.0 - 18.0)    | 1.22 (31.0)            | .43 (11.0) | 1.30 (33.0) |
| CD25MR-BK-N   | CD25MR-GY-N |        | .35 - .63 (9.0 - 16.0)     |                        |            |             |
| CD32MA-BK-N   | CD32MA-GY-N | M32    | .71 - .98 (18.0 - 25.0)    | 1.54 (39.0)            | .43 (11.0) | 1.65 (42.0) |
| CD32MR-BK-N   | CD32MR-GY-N |        | .51 - .79 (13.0 - 20.0)    |                        |            |             |
| CD40MA-BK-N   | CD40MA-GY-N | M40    | .86 - 1.26 (22.0 - 32.0)   | 1.89 (48.0)            | .51 (13.0) | 2.09 (53.0) |
| CD40MR-BK-N   | CD40MR-GY-N |        | .79 - 1.02 (20.0 - 26.0)   |                        |            |             |
| CD50MA-BK-N   | CD50MA-GY-N | M50    | 1.26 - 1.50 (32.0 - 38.0)  | 1.93 (49.0)            | .51 (13.0) | 2.36 (60.0) |
| CD50MR-BK-N   | CD50MR-GY-N |        | .98 - 1.22 (25.0 - 31.0)   |                        |            |             |

For other Strain Relief Products call Sealcon at 800.456.9012 or 303.699.1135. Visit Sealcon's Web site [www.sealconusa.com](http://www.sealconusa.com) or E-Mail [info@sealconusa.com](mailto:info@sealconusa.com)

# GROMMETS NEMA 4x & 12 (IP 65)

Material: Thermoplastic Elastomer

Cut out scored center. Push cable through grommet. Features a double seal.  
Does not provide strain relief for the cable. Can be used to plug a hole.

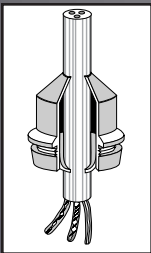
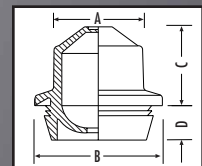

| ORDER NUMBER | PANEL HOLE |             | PANEL WALL THICKNESS  | CABLE RANGE<br>INCHES (MM) | DIMENSIONS INCHES (MM) |             |            |           |
|--------------|------------|-------------|-----------------------|----------------------------|------------------------|-------------|------------|-----------|
|              | BASIC      | DRILLED     |                       |                            | A                      | B           | C          | D         |
| EDK 20       | M20        | .81 (20.5)  | .06 - .14 (1.5 - 3.5) | .24 - .51 (6.0 - 13.0)     | .73 (18.5)             | 1.02 (26.0) | .57 (14.5) | .33 (8.5) |
| EDK 25       | M25        | 1.00 (25.5) | .06 - .14 (1.5 - 3.5) | .35 - .67 (9.0 - 17.0)     | .93 (23.5)             | 1.22 (31.0) | .57 (14.5) | .33 (8.5) |
| EDK 32       | M32        | 1.28 (32.5) | .06 - .14 (1.5 - 3.5) | .47 - .91 (12.0 - 23.0)    | 1.20 (30.5)            | 1.50 (38.0) | .77 (19.5) | .33 (8.5) |
| EDK 40       | M40        | 1.59 (40.5) | .06 - .14 (1.5 - 3.5) | .67 - 1.18 (17.0 - 30.0)   | 1.52 (38.5)            | 1.81 (46.0) | .77 (19.5) | .33 (8.5) |

# STEPPED GLANDS NEMA 2 (IP 54)

Material: Thermoplastic Elastomer

Cut off appropriate step to fit cable. Push cable through gland. Does not provide strain relief for the cable. Can be used to plug a hole.

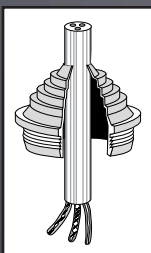
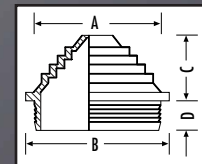

| ORDER NUMBER | PANEL HOLE |             | PANEL WALL THICKNESS  | CABLE RANGE<br>INCHES (MM) | DIMENSIONS INCHES (MM) |             |            |           |
|--------------|------------|-------------|-----------------------|----------------------------|------------------------|-------------|------------|-----------|
|              | BASIC      | DRILLED     |                       |                            | A                      | B           | C          | D         |
| STM 20       | M20        | .81 (20.5)  | .06 - .16 (1.5 - 4.0) | .20 - .63 (5.0 - 16.0)     | .71 (18.0)             | .98 (25.0)  | .36 (9.2)  | .31 (8.0) |
| STM 25       | M25        | 1.00 (25.5) | .06 - .16 (1.5 - 4.0) | .20 - .83 (5.0 - 21.0)     | .85 (21.6)             | 1.18 (30.0) | .45 (11.5) | .29 (7.4) |
| STM 32       | M32        | 1.28 (32.5) | .06 - .16 (1.5 - 4.0) | .51 - 1.04 (13.0 - 26.5)   | 1.09 (27.6)            | 1.46 (37.0) | .45 (11.5) | .34 (8.6) |
| STM 40       | M40        | 1.59 (40.5) | .06 - .16 (1.5 - 4.0) | .51 - 1.34 (13.0 - 34.0)   | 1.32 (33.6)            | 1.77 (45.0) | .59 (15.1) | .34 (8.6) |